

# Photomicrosensor (Transmissive)

# EE-SX1025

## Slot / PCB mounting Type (Slot width: 2.8 mm)

- Low-profile model (5.4 mm high)
- With a positioning boss

 Be sure to read *Safety Precautions* on page 3.

RoHS Compliant

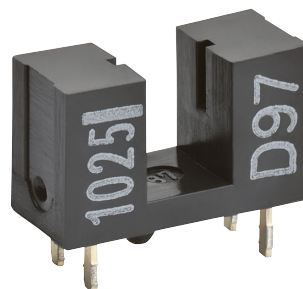

## Model Number Structure

**EE-S X 1 025**

(1)	(2)	(3)	(4)
Photomicrosensor	Transmissive	Phototransistor output	Serial number

## Ordering Information

### Photomicrosensor

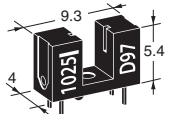
Appearance	Sensing method	Connecting method	Sensing distance	Aperture size (H × W) (mm)	Output type	Model	Minimum packing unit (Unit: pcs)
	Transmissive (slot type)	PCB mounting	<b>2.8 mm</b> (slot width)	Both emitting side and detecting side 1.4 × 0.5	Phototransistor	<b>EE-SX1025</b>	<b>1</b>

Note: Order in multiples of minimum packing unit.

## Ratings, Characteristics and Exterior Specifications

### Absolute Maximum Ratings (Ta = 25°C)

Item	Symbol	Rated value	Unit
<b>Emitter</b>			
Forward current	I <sub>F</sub>	50 *1	mA
Pulse forward current	I <sub>FP</sub>	1 *2	A
Reverse voltage	V <sub>R</sub>	4	V
<b>Detector</b>			
Collector-emitter voltage	V <sub>CEO</sub>	30	V
Collector current	I <sub>C</sub>	20	mA
Collector dissipation	P <sub>C</sub>	100 *1	mW
<b>Ambient temperature</b>			
Operating	T <sub>opr</sub>	-25 to 85	°C
Storage	T <sub>stg</sub>	-30 to 100	°C
Soldering temperature	T <sub>sol</sub>	260 *3	°C

\*1. Refer to the temperature rating chart if the ambient temperature exceeds 25°C.

\*2. The pulse width is 10 μs maximum with a frequency of 100 Hz.

\*3. Complete soldering within 10 seconds.

### Exterior Specifications

Connecting method	Weight (g)	Material
		Case
PCB mounting	0.19	PBT

### Electrical and Optical Characteristics (Ta = 25°C)

Item	Symbol	Value			Unit	Condition
		MIN.	TYP.	MAX.		
<b>Emitter</b>						
Forward voltage	V <sub>F</sub>	---	1.2	1.5	V	I <sub>F</sub> = 30 mA
Reverse current	I <sub>R</sub>	---	0.01	10	μA	V <sub>R</sub> = 4 V
Peak emission wavelength	λ <sub>P</sub>	---	940	---	nm	I <sub>F</sub> = 20 mA
<b>Detector</b>						
Light current	I <sub>L</sub>	0.5	---	14	mA	I <sub>F</sub> = 20 mA V <sub>CE</sub> = 10 V
Dark current	I <sub>D</sub>	---	2	200	nA	V <sub>CE</sub> = 10 V I <sub>L</sub> = 0 μA
Leakage current	I <sub>LEAK</sub>	---	---	---	μA	---
Collector-emitter saturated voltage	V <sub>CE (sat)</sub>	---	0.1	0.4	V	I <sub>F</sub> = 20 mA I <sub>L</sub> = 0.1 mA
Peak spectral sensitivity wavelength	λ <sub>P</sub>	---	850	---	nm	V <sub>CE</sub> = 10 V
Rising time	t <sub>r</sub>	---	4	---	μs	V <sub>CC</sub> = 5 V R <sub>L</sub> = 100 Ω
Falling time	t <sub>f</sub>	---	4	---	μs	I <sub>L</sub> = 5 mA

Engineering Data (Reference value)

Fig1. Forward Current vs. Collector Dissipation Temperature Rating

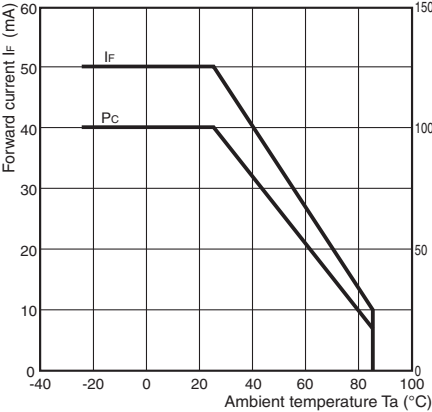

Fig2. Forward Current vs. Forward Voltage Characteristics (Typical)

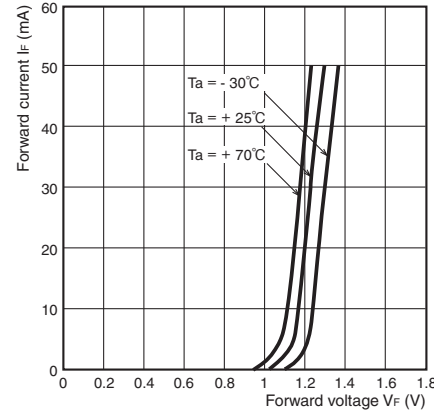

Fig3. Light Current vs. Forward Current Characteristics (Typical)

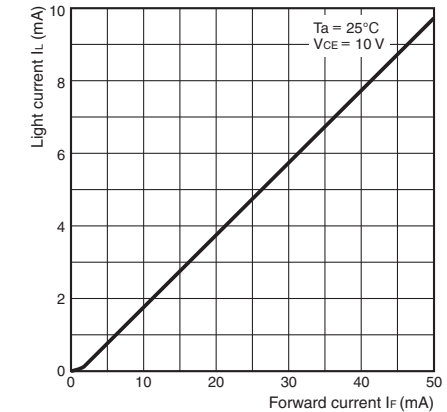

Fig4. Light Current vs. Collector-Emitter Voltage Characteristics (Typical)

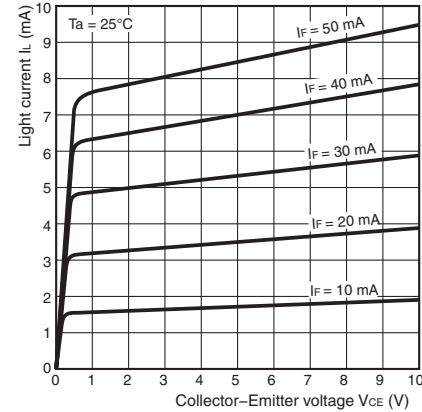

Fig5. Relative Light Current vs. Ambient Temperature Characteristics (Typical)

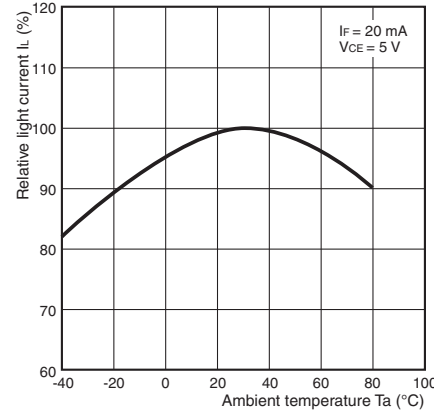

Fig6. Dark Current vs. Ambient Temperature Characteristics (Typical)

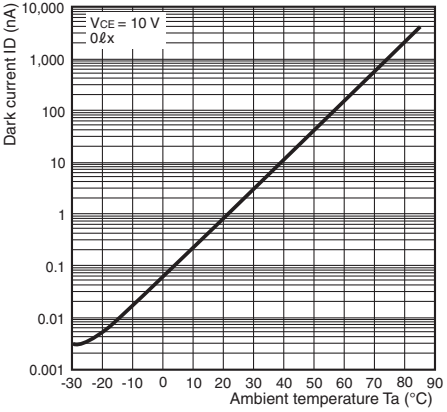

Fig7. Response Time vs. Load Resistance Characteristics (Typical)

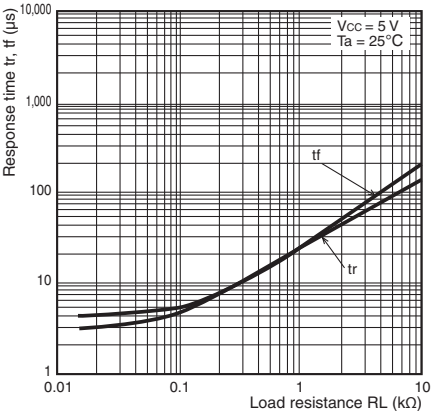

Fig8. Sensing Position Characteristics (Typical)

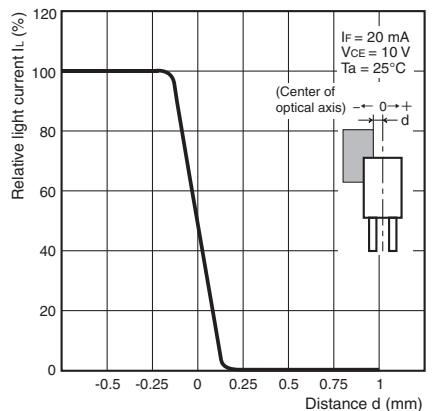

Fig9. Sensing Position Characteristics (Typical)

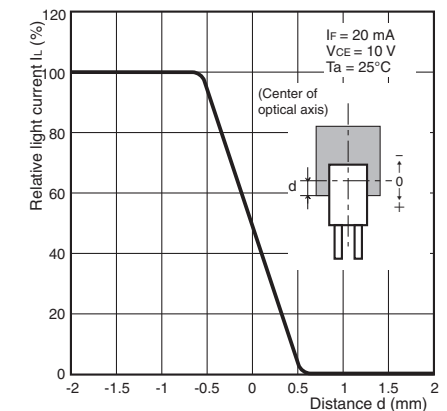
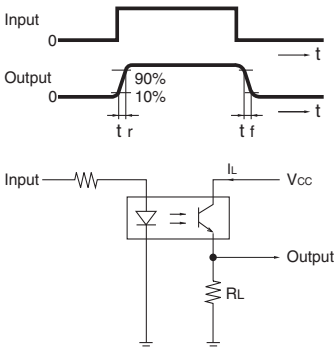

Fig10. Response Time Measurement Circuit



## Safety Precautions

To ensure safe operation, be sure to read and follow the Instruction Manual provided with the Sensor.

### CAUTION

This product is not designed or rated for ensuring safety of persons either directly or indirectly. Do not use it for such purposes.



### Precautions for Correct Use

Do not use the product in atmospheres or environments that exceed product ratings.

### Precautions for Safe Use

Do not use the product with a voltage or current that exceeds the rated range.

Applying a voltage or current that is higher than the rated range may result in explosion or fire.

Do not miswire such as the polarity of the power supply voltage.

Otherwise the product may be damaged or it may burn.

This product does not resist water. Do not use the product in places where water or oil may be sprayed onto the product.

## Dimensions and Internal Circuit

(Unit: mm)

### Photomicrosensor

EE-SX1025

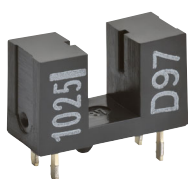

Aperture size (H × W)

Emitter	Detector
1.4 × 0.5	1.4 × 0.5

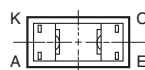
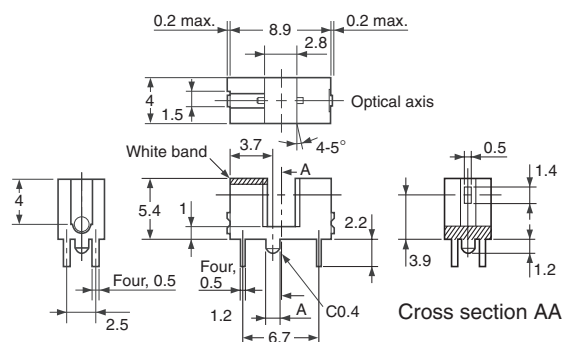

Internal circuit

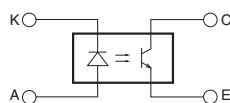

Terminal No.	Name
A	Anode
K	Cathode
C	Collector
E	Emitter

Unless otherwise specified, the tolerances are as shown below.

Dimensions	Tolerance
3 mm max.	±0.3
3 < mm ≤ 6	±0.375
6 < mm ≤ 10	±0.45
10 < mm ≤ 18	±0.55
18 < mm ≤ 30	±0.65

Please check each region's Terms & Conditions by region website.

---

## **OMRON Corporation**

**Electronic and Mechanical Components Company**

### **Regional Contact**

#### **Americas**

<https://www.components.omron.com/>

#### **Asia-Pacific**

<https://ecb.omron.com.sg/>

#### **Korea**

<https://www.omron-ecb.co.kr/>

#### **Europe**

<http://components.omron.eu/>

#### **China**

<https://www.ecb.omron.com.cn/>

#### **Japan**

<https://www.omron.co.jp/ecb/>